

Merchandise Express™ Kit 05

ME-K-05

Merchandise Express™ is a portable point of purchase display system that features simple black metal frames, shelving, pegboards and push-fit fabric graphics to deliver products and messaging with an impact! Convenient rolling carry bags make transportation easy.

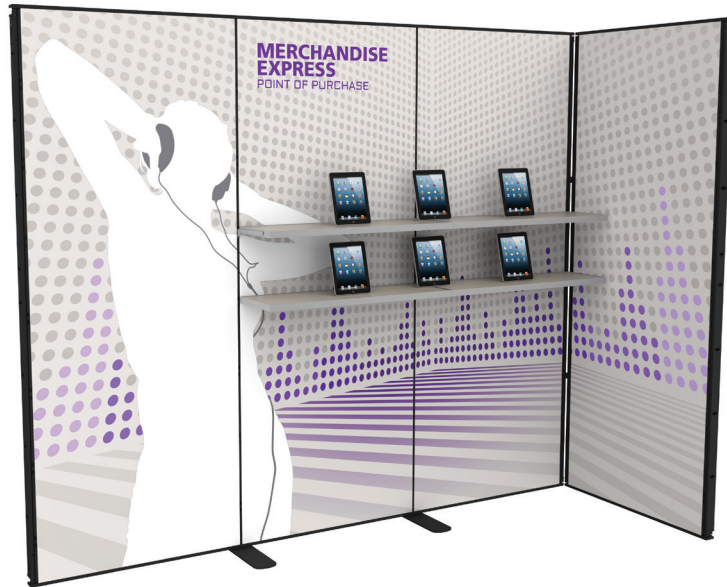

features and benefits:

- NEW
- 9½'w full height straight backwall
- Black metal frames with support feet
- Two rolling carry bags and one accessory bag included
- Kit includes: frame, 5 fabric graphic panels and 4 adjustable height shelves
- One year limited hardware warranty against manufacturers defects

dimensions:

Hardware	Graphic
<p>Assembled unit: 113.94" w x 94.92" h x 41.22" d 2944mm(w) x 2411mm(h) x 1047mm(d)</p> <p>Approximate weight: 138.5 lbs / 62.82 kgs</p>	<p>Total visual area: Graphic Panels A, B, C, D and E: 36.875" w x 93.25" h</p> <p>Please be sure to include a 2" bleed around the perimeter.</p>
<p>Shipping</p> <p>Shipping dimensions (ships in 2 boxes): Box 1: 53" l x 18" h x 16" d 1346mm(l) x 457m(h) x 406mm(d) Box 2 : 53" l x 12" h x 8" d 1346mm(l) x 305mm(h) x 203mm(d)</p> <p>Approximate shipping weight: 150 lbs / 68 kgs</p>	<p>Refer to related graphic template for more information.</p> <p>Visit: www.exhibitors-handbook.com/graphic-templates</p>
<p>additional information:</p> <p>Optional a la carte accessories: Shelf Full Kit 1 (1 Shelf): BME1-SHLF-FK1</p> <p>Shelf Full Kit 2 (2 Shelves): BME1-SHLF-FK2</p> <p>Pegboard Full Kit 1 (1 Pegboard): BME1-DSPLY-PNL-FK1</p> <p>Pegboard Full Kit 2 (2 Pegboards): BME1-DSPLY-PNL-FK2</p> <p>Accessory Combo Kit (1 Shelf & 1 Pegboard): BME1-ACC-CMB</p> <p>Monitor Bracket Full Kit: BME1-MB</p>	<p>Graphic material: dye-sublimated fabric</p> <p>Max weight per shelf = 10 lbs / 4.5 kgs</p> <p>Lumina 200 LED - 25 LED watts</p> <p>*Kit does not include tablets</p> <p>Hard case options available for shipping. Call your sales representative today for more information.</p>

We are continually improving and modifying our product range and reserve the right to vary the specifications without prior notice. All dimensions and weights quoted are approximate and we accept no responsibility for variance. E&OE. See Graphic Templates for graphic bleed specifications.

Parts Included:

Qty	Description
8	Horizontal bar (HZ-BAR)
4	Hanging bar (HNG-BAR)
6	Vertical pole top (VPL-T)
2	Vertical pole bottom for foot (VPL-BTM)
4	Vertical pole bottom with raised pad (VPL-BTM-RP)
2	Foot
4	Shelf Kit
2	Corner Connector

Packing Solution:

Hard case options available for shipping. Call your sales representative for more information. Below are lists of content per carry bag and accessory bag.

Two Rolling Carry Bags:

- all vertical posts

Accessory Bag:

- all horizontal bars

- all hanging bars

- feet

- accessories

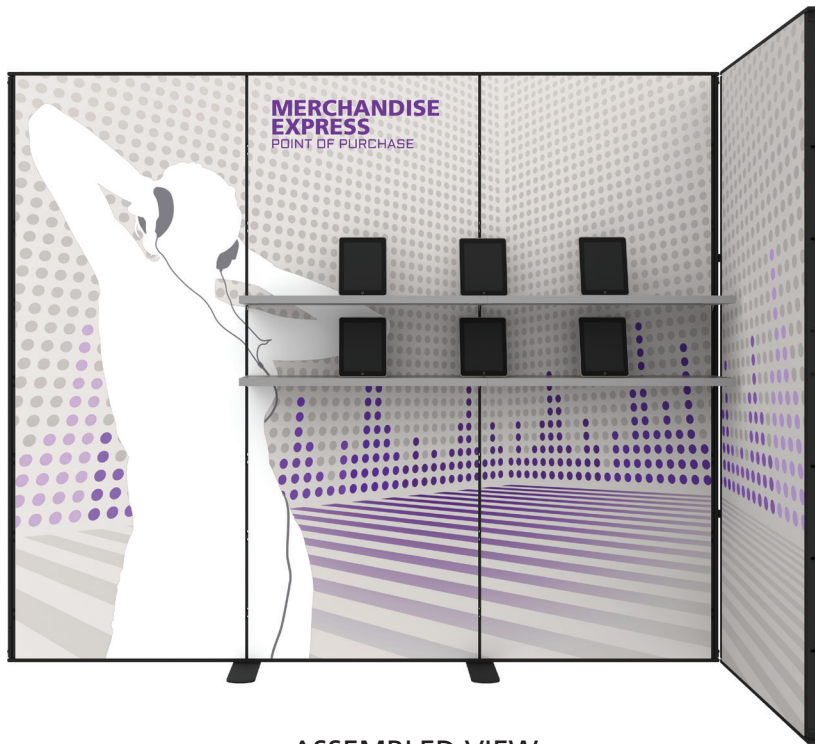

ASSEMBLED VIEW

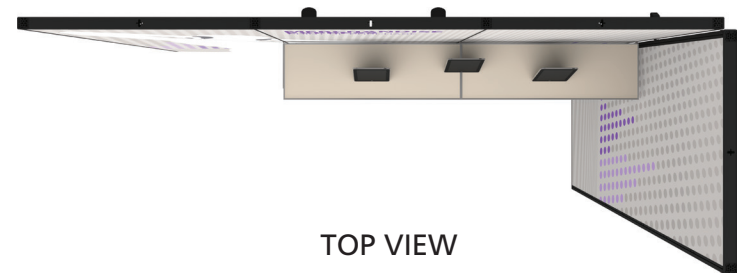

TOP VIEW

Step 1: Assemble Outside Vertical Posts

Assemble right outside post by sliding top vertical post (VPL-T) to bottom vertical post (VPL-BTM-RP.) Repeat for left outside post.

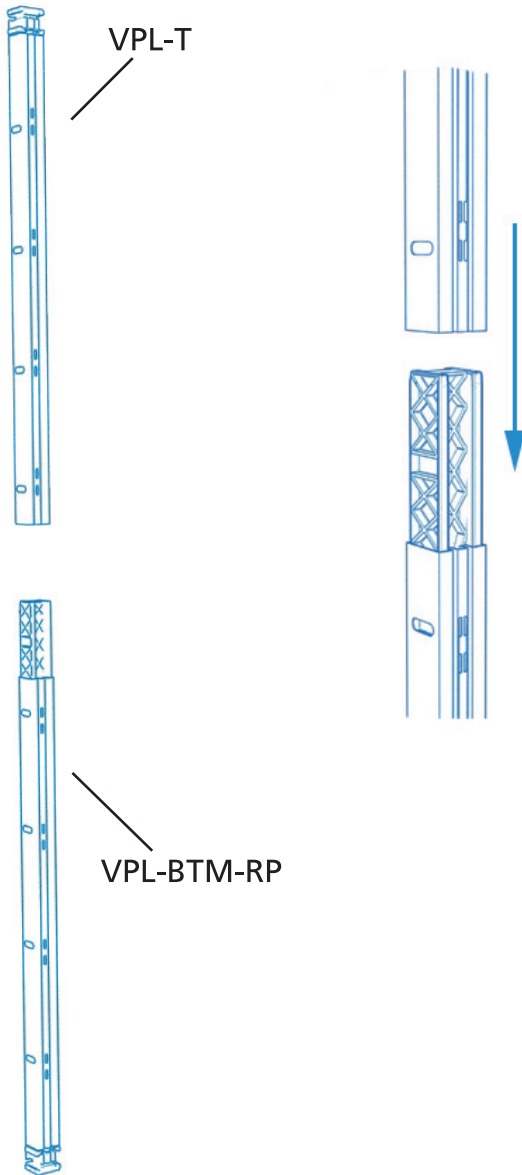

Step 2: Attach Feet to Center Posts

To attach the vertical pole bottom (VPL-BTM) to foot, lift the lever on the post and slide onto the foot. Then, push the lever down and lock the post onto the foot.

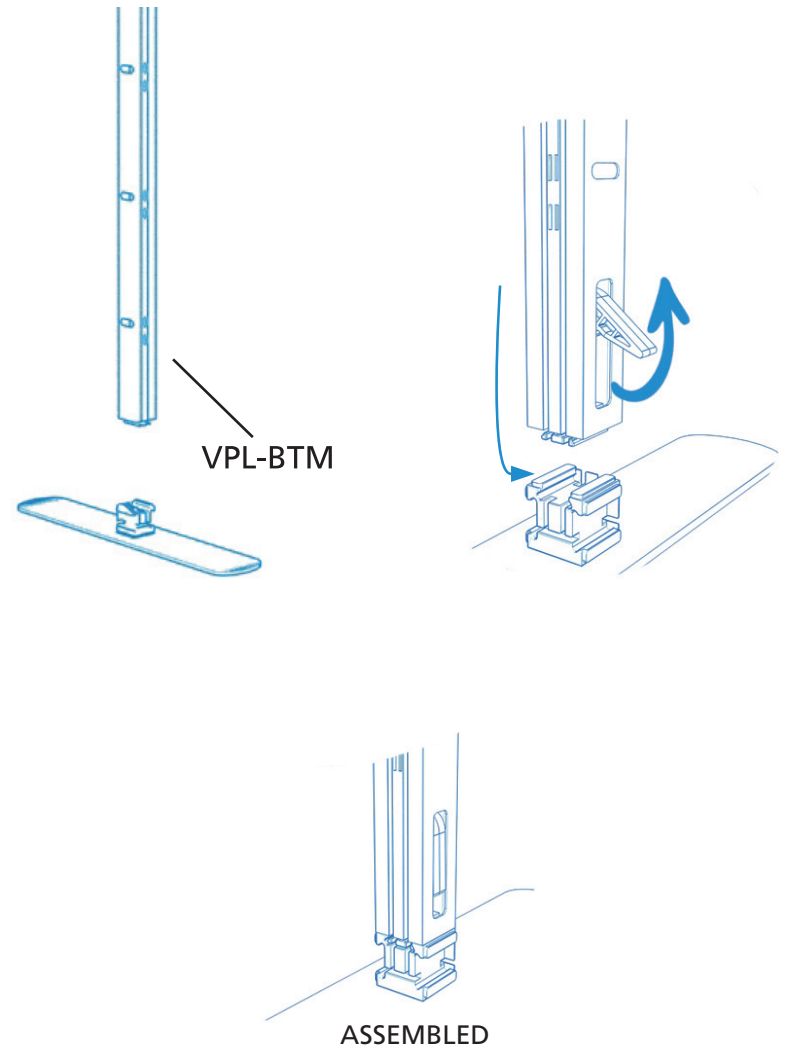

Step 3: Assemble Center Vertical Posts

Connect left center post by sliding top vertical post (VPL-T) to bottom vertical post with foot (VPL-BTM.) Repeat for right center post.

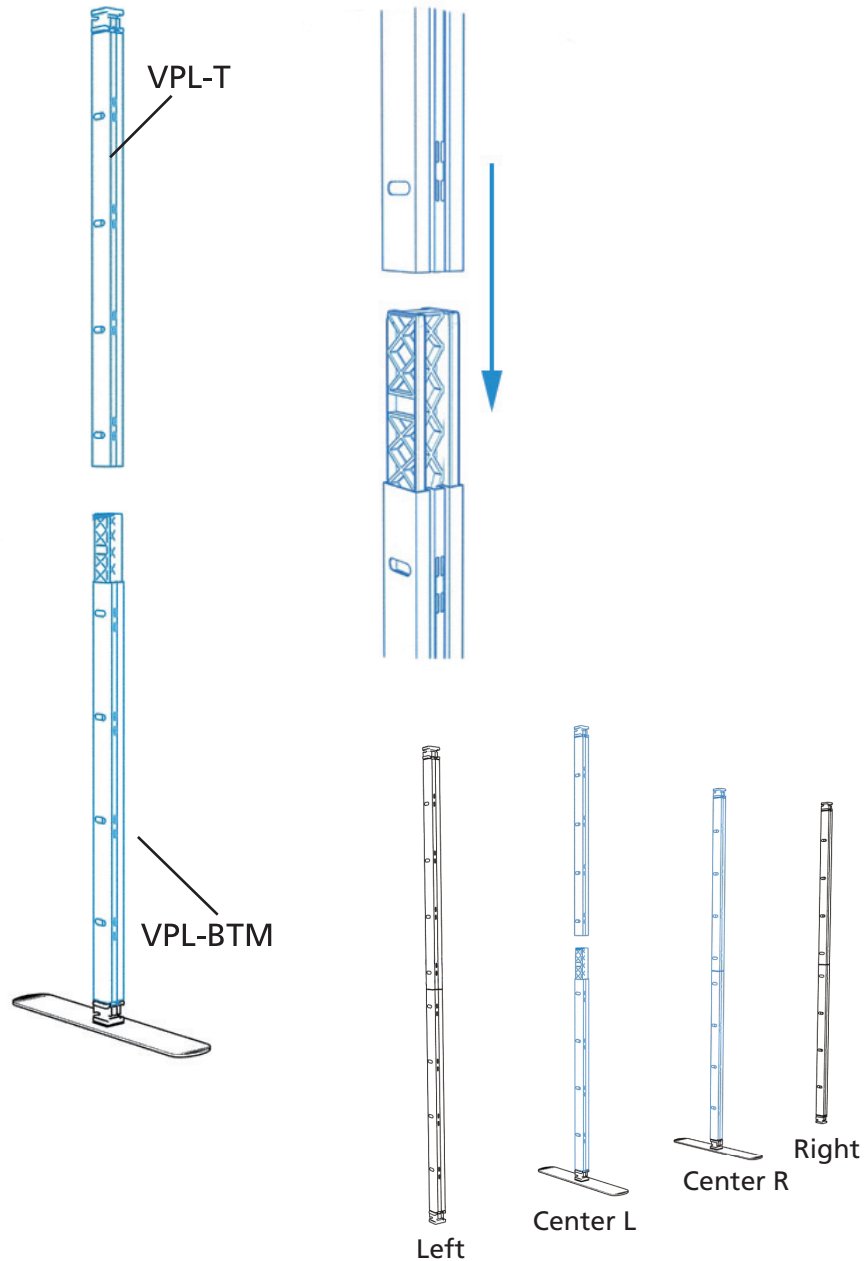

Step 4: Attach Top and Bottom Bars

Attach top and bottom horizontal bars of frame to vertical posts. First, line up the horizontal bar (HZ-BAR) with the bottom left vertical post and with the center vertical post. Lift the lever on the horizontal bar (HZ-BAR) and slide onto the left vertical post. Then, push the lever down to lock. Secure the bottom horizontal bar (HZ-BAR) by locking to the center vertical post. Repeat on top and bottom for each panel.

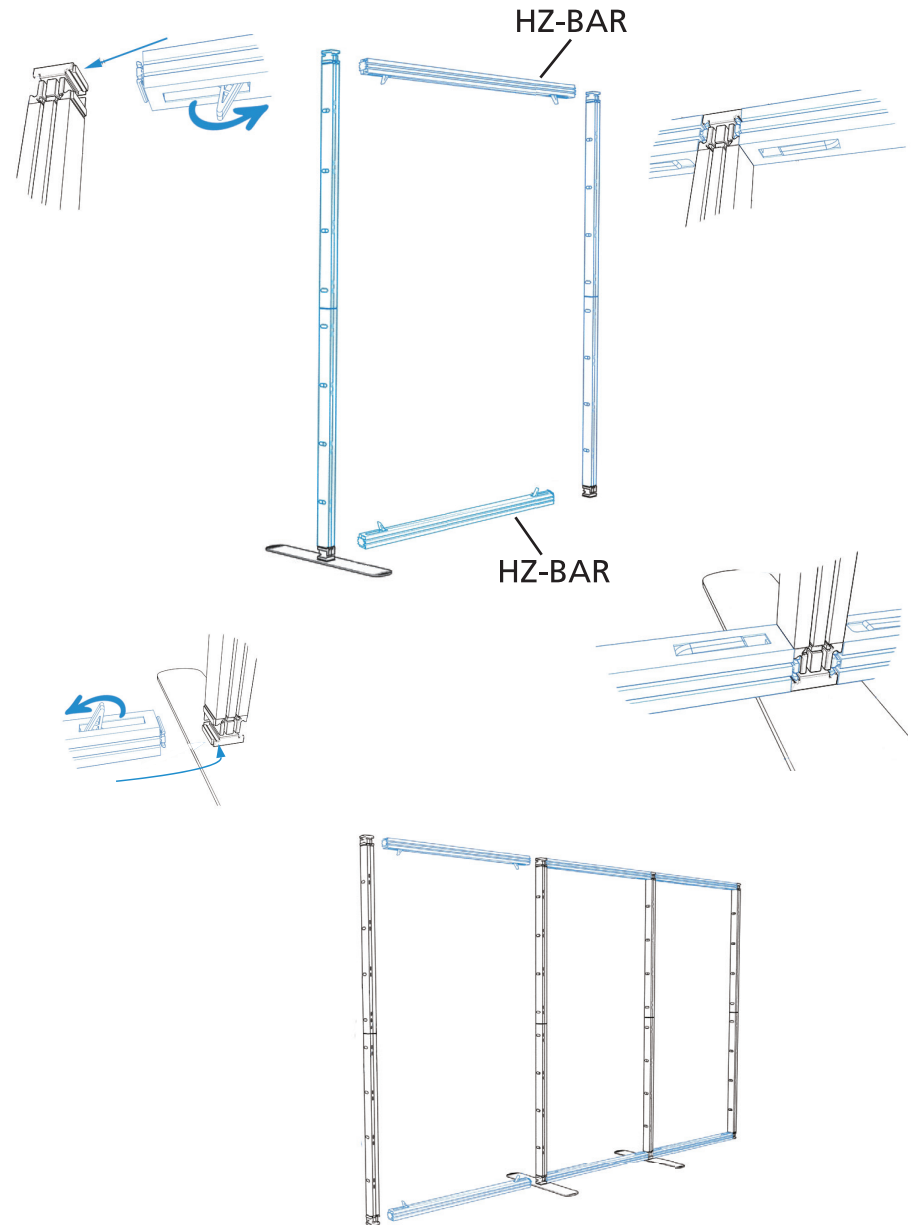

Step 5: Assemble Side Panels

Refer to Step 1 to assemble left and right vertical posts. Attach top and bottom horizontal bars of frame to vertical posts. First, line up the horizontal bar (HZ-BAR) with the bottom left vertical post and with the right vertical post. Lift the lever on the horizontal bar (HZ-BAR) and slide onto the left vertical post. Then, push the lever down to lock. Secure the bottom horizontal bar (HZ-BAR) by locking to the right vertical post.

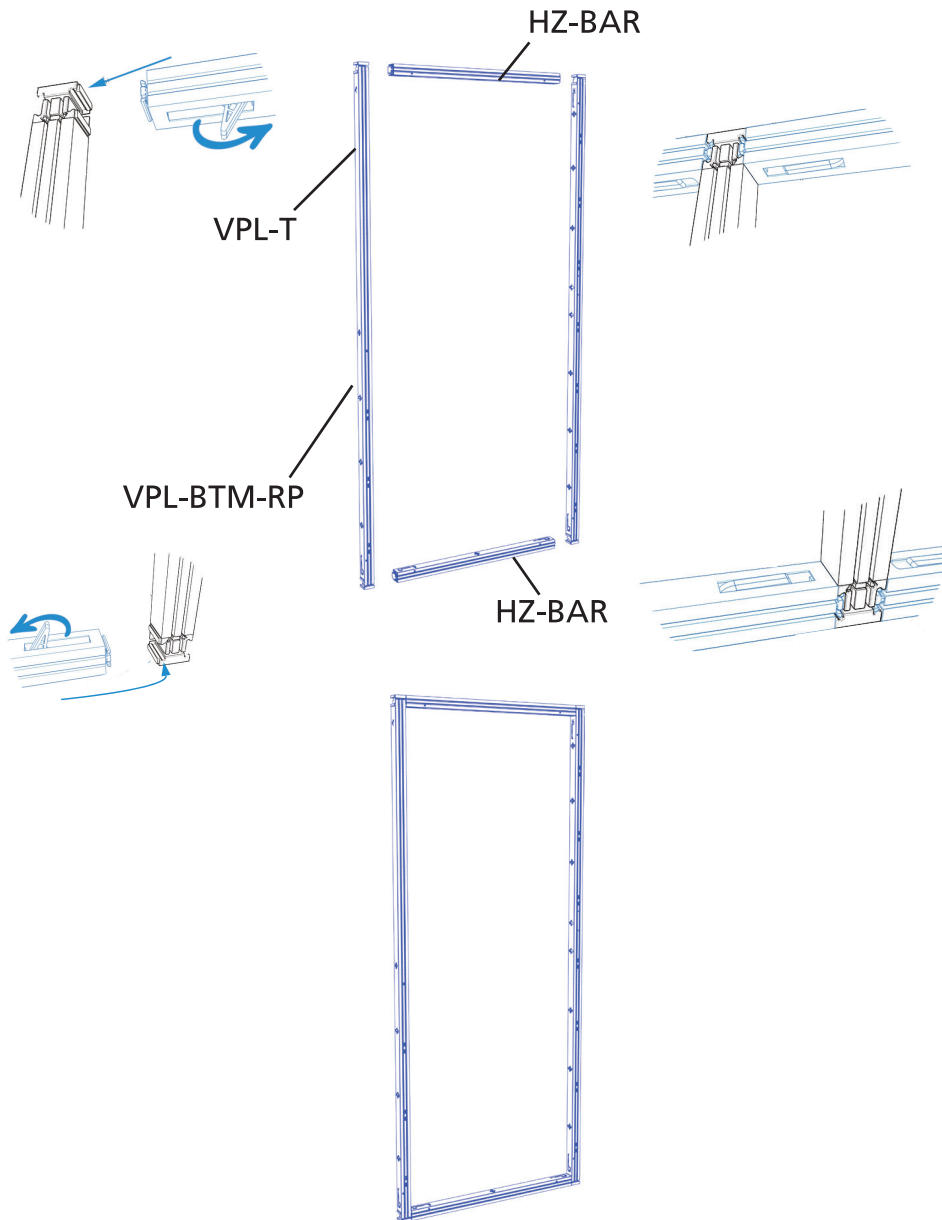

Step 6: Attach Side Panel

Insert corner brackets into opening on the side of the vertical post. Insert winged screw into corresponding hole on the opposite side of the vertical post and twist until tightened. Repeat for each side of the corner, using one connector toward the top of the frame and another near the bottom.

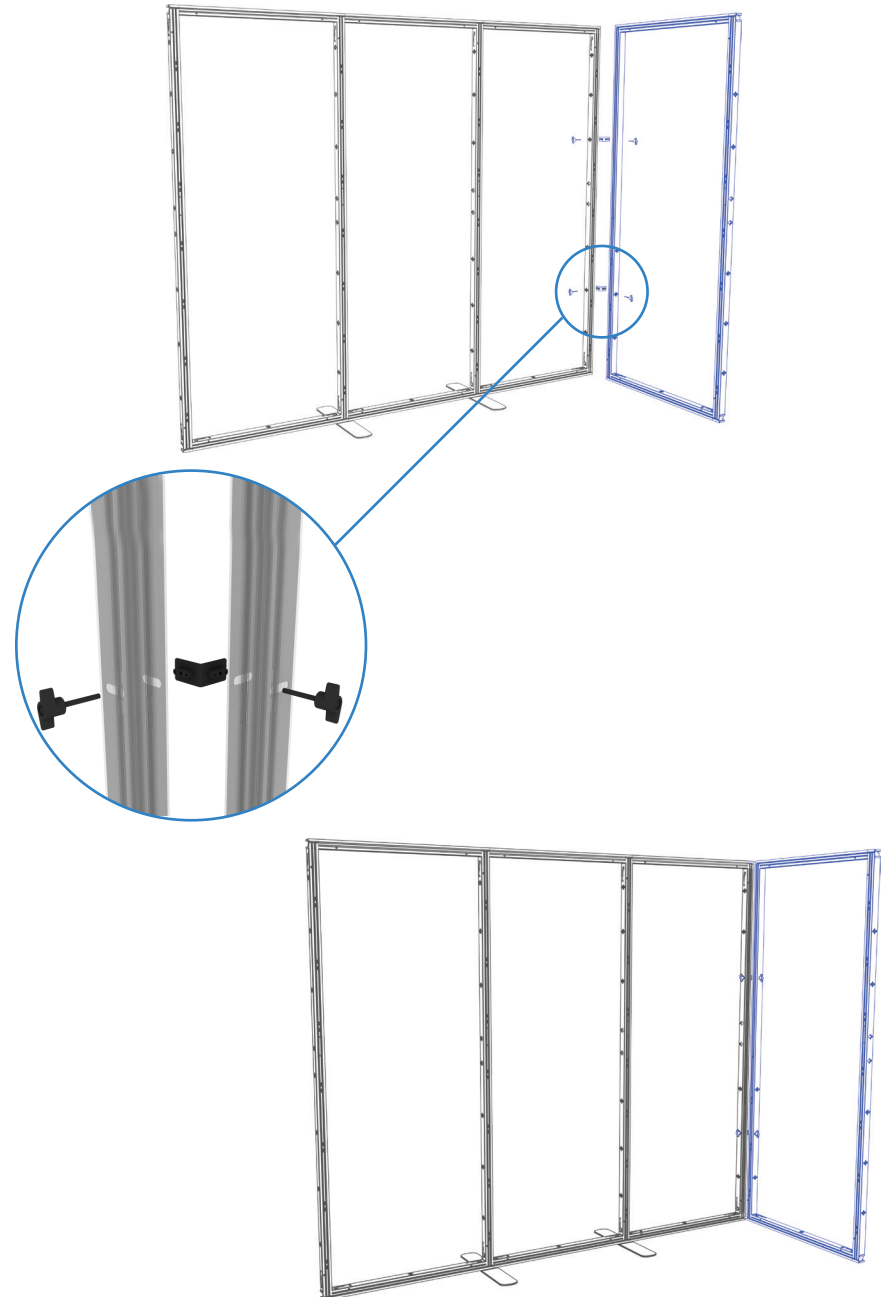

Step 7: Attach Center Support Bar

For support, hang the center support bar (HNG-BAR) in each panel. Attach support bars by connecting in vertical post notches. Repeat for each panel. Stagger the center support bars across kit.

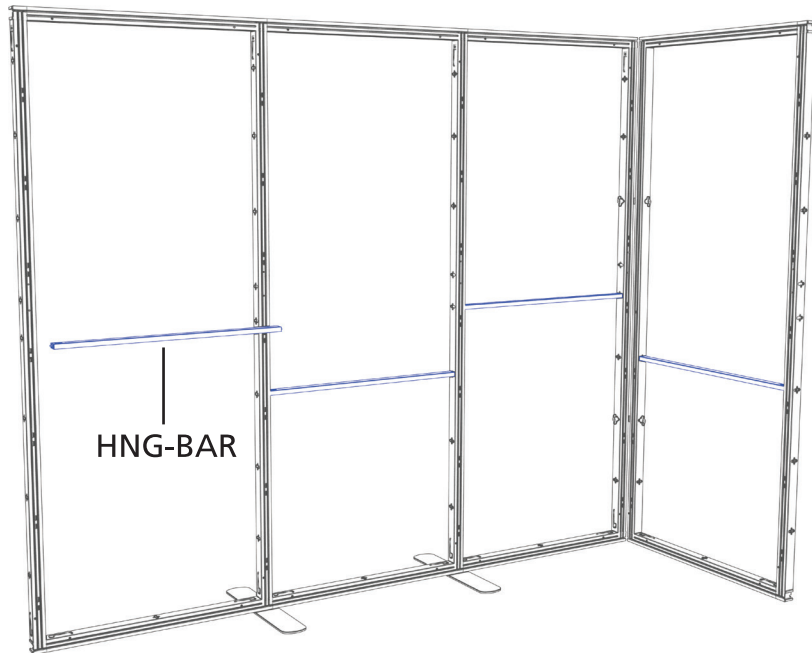
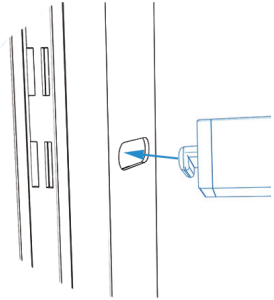

Step 8: Apply Graphics

Install graphics by folding the graphic over the silicone edge. Start by inserting graphic into each corner of each panel. Graphic inserts into inside channels on the right and left sides and the outside channel on top and bottom. Then push the graphic into the channel around the perimeter of the frame. Assure each graphic is tightly inserted. When taking graphics off, take care to gently pull by attached pull tab.

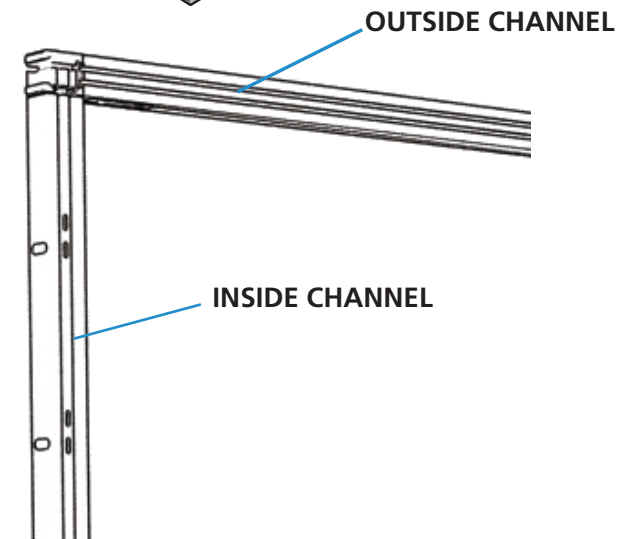
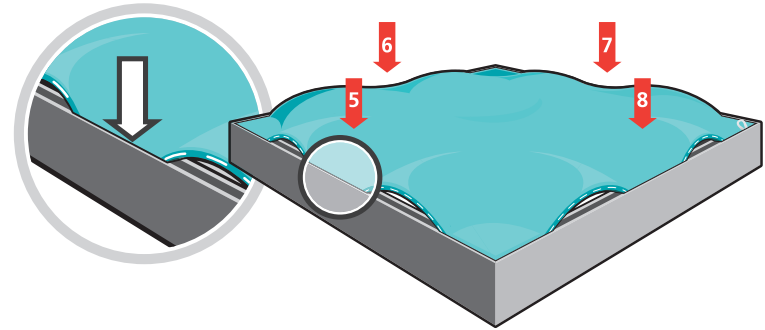
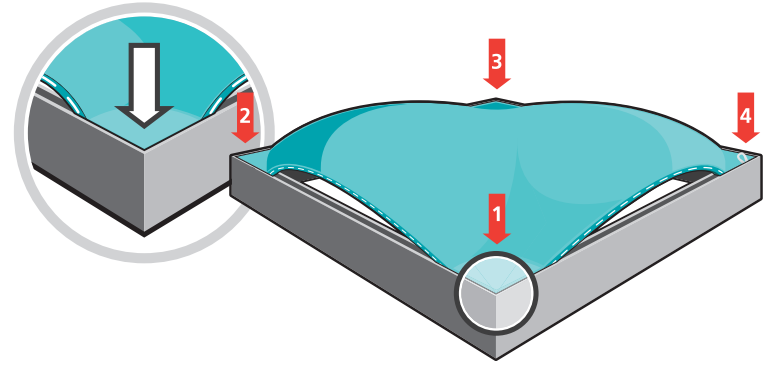

Step 9: Attach Shelving

Attach shelving by connecting to vertical post notches at desired height location. Repeat for each shelf.

